



Features

- Dimmable LED LUM™ task lighting with integrated touch control
- Energy efficient LED lighting 4000-4500K CCT
- 55 foot-candle at standard user distance
- CRI 90+
- Includes two USB charging outlets (bottom and right side)

Construction

- Powder coated steel back frame
- Quality polished edge mirror
- Single field wire installation
- Constructed for surface mounting
- Includes installation hardware

Codes/Standards Applicable

- AiO Mirror is ETL certified to:
 - UL 1598
 - CSA Standard C22.2 No. 250.0

Dimensions

Height: 29-7/8" (759 mm)
 Width: 29-1/8" (740 mm)
 Depth: 1-1/2" (38 mm)

Options

- OM™ Audio

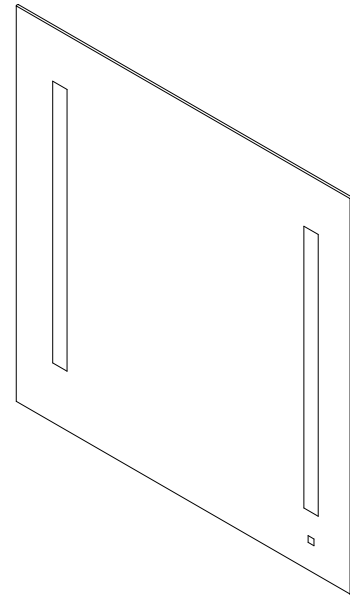

Model Number Key

AiO	Mirror	Width	Height	Touch Switch Side	Mirror Style	Options
A	M	30	30	R = Right	FP = Flat	Blank = Without Robern Audio A = OM Audio

Electrical System

- 120 Vac 60Hz 1.2A - Field Wire location as shown in drawing
- 1/2" conduit (7/8" actual) electrical knockout location shown (alternative location provided)

OM Audio

- Vibrating Glass Technology - Resulting in a hidden audio system
- Wide Dispersion - Almost 160 degrees from the door surface
- Bluetooth® Connection
- Range: Up To 30 feet / 9.1 meters (depending on interference)
- 2 Channel Stereo
- 20 Watts / Channel
- Supports most Android and iOS devices: Smartphones, PCs, Tablets, and other Bluetooth enabled devices. Volume controlled by device.
- Audio amplifier with Bluetooth connectivity for wireless streaming of audio input
- Plays your music or audio preferences and selections from any Bluetooth enabled device.

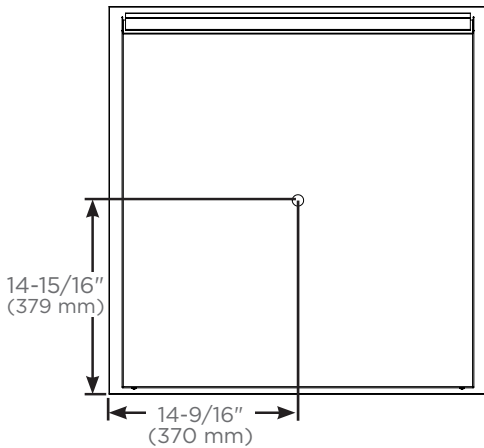

Back view for electrical knockout location

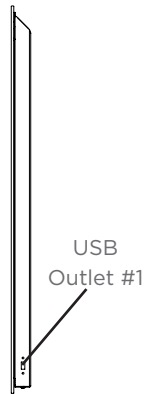

Side view

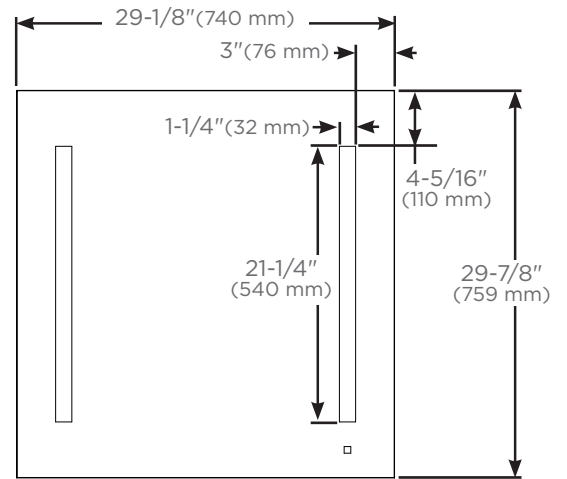

Front view

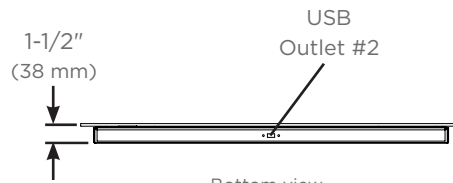

Bottom view