

SILGRANIT®

Double Bowl 60/40 Undermount

LUXART®

Product Specifications

MODELS

- LX441128 Double Bowl, 9-1/2" bowl depth, ANTHRACITE
- LX441129 Double Bowl, 9-1/2" bowl depth, CAFÉ BROWN
- LX441125 Double Bowl, 9-1/2" bowl depth, WHITE
- LX441130 Double Bowl, 9-1/2" bowl depth, METALLIC GRAY
- LX441296 Double Bowl, 9-1/2" bowl depth, TRUFFLE
- LX441479 Double Bowl, 9-1/2" bowl depth, CINDER
- LX442926 Double Bowl, 9-1/2" bowl depth, COAL BLACK
- LX443081 Double Bowl, 9-1/2" bowl depth, SOFT WHITE
- LX443118 Double Bowl, 9-1/2" bowl depth, VOLCANO GRAY



Model LX441128 shown in ANTHRACITE

* basket strainer not included

FEATURES

- Required outside cabinet: 36"
- 80% solid granite
- Heat resistant up to 536°F
- Unsurpassed cleanability backed by industry leading 7patents!
- Resistant to scratches, stains and all household acids and alkalisolutions
- Template provided with approximate 1/8" reveal
- Undermount clips included
- Limited lifetime warranty

OPTIONAL ACCESORIES

- Celcon Disposal Flange with Strainer/Stopper: LX125
- Celcon Basket Strainer: LX105

CODE/STANDARDS COMPLIANCE

ANSIZ124.6-97
IAPMO/UPClisted

NOMINAL DIMENSIONS

OVERALL	CUTOUT SIZE	BOWL DEPTH		DRAIN DIAMETER
		LEFT	RIGHT	
33"X18"	Template provided with approximate 1/8" reveal	9-1/2"	9-1/2"	3-1/2"

DFX cutout templates available on our website

All dimensions listed are nominal. Luxart® reserves the right to make product and material changes at any time without notice.



Contact your sales representative for more information or visit our website at luxartcollection.com

SILGRANIT® Double Bowl 60/40 Undermount

LUXART®

Product Specifications

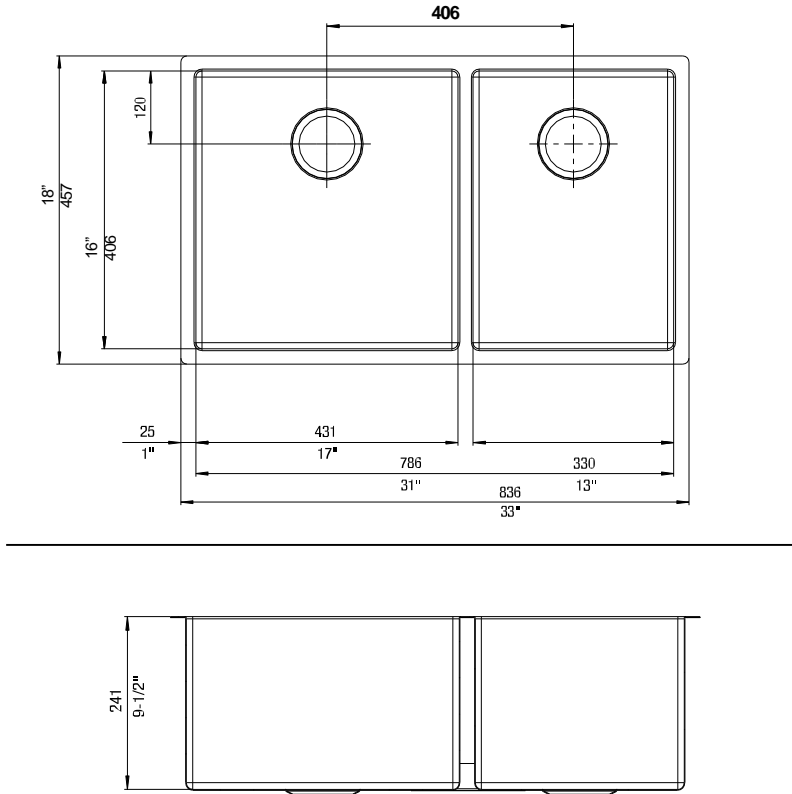

Contact your sales representative for more information or visit our website at luxartcollection.com

Revised 2/07/2023