

## Features

- Premium construction ensures durability and reliability



## Codes/Standards







ASME A112.18.1/CSA B125.1

## KOHLER® Faucet Lifetime Limited Warranty

See website for detailed warranty information.

## Available Colors/Finishes

*Color tiles intended for reference only.*

Color	Code	Description
	CP	Polished Chrome
	SN	Vibrant® Polished Nickel
	PGD	Vibrant® Moderne Polished Gold
	BGD	Vibrant® Moderne Brushed Gold
	BN	Vibrant® Brushed Nickel
	BV	Vibrant® Brushed Bronze

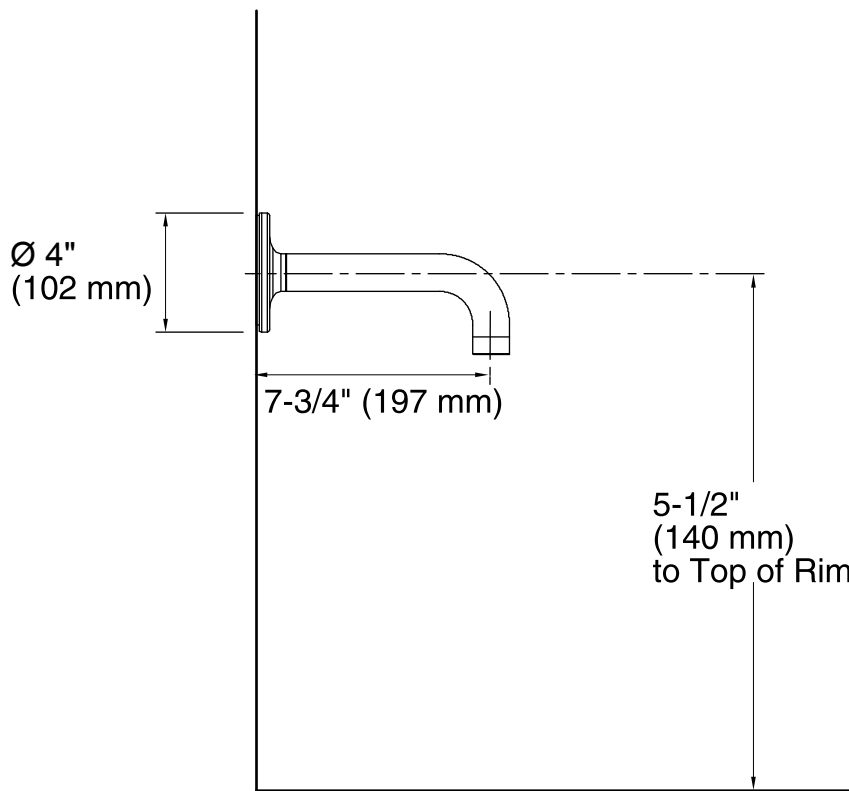

**Technical Information**

All product dimensions are nominal.

**Notes**

Install this product according to the installation guide.