

## 003621 | URBANEDGE®

UNDERMOUNT STAINLESS STEEL KITCHEN SINK

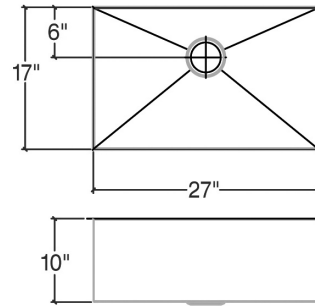

### Specifications

Model	003621
Collection	UrbanEdge®
Bowl dimensions	27" × 17" × 10"
Overall dimensions	28 1/2" × 18 1/2" × 10"
Recommended cabinet	33"

### Recommended accessories

Drain	100082
Grid (coming soon)	200914
Colander	205224
Bin	205227
Tray	205233
Cutting board	210065
Drying Rack	215207

### Warranty

Home Refinements offers a LIMITED LIFETIME WARRANTY on the fixed components of its stainless steel sinks against defects of material and workmanship. For further details on our product warranty, please refer to our catalog or Web site.

### Features

- Handcrafted in Canada
- Commercial quality stainless steel - 16 ga thickness
- Corrosion resistant material - 304 series (18/10)
- Environmentally friendly product, 100% recyclable
- Elegant no. 4 brushed finish that matches the appliances
- Highly efficient sound deadening pads
- Practical flat sink bottom and straight bowl sides that maximize available space in the bowl
- Stylish and functional bowl bottom grooves that facilitate water drainage
- Rear 3-1/2" drain placement
- Mounting hardware and cutout template included
- Certifications: ASME A112.19.3, CSA B45.0, CSA B45.4