

60" S

Item Number:

- 147-114-5331
- 147-114-5341
- 147-114-5361
- 147-114-5371
- 147-114-5381

JAMES MARTIN

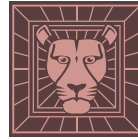

VANITIES™

Brookfield 60" Cabinet

Diagrams with Dimensions  
page 01 of 03

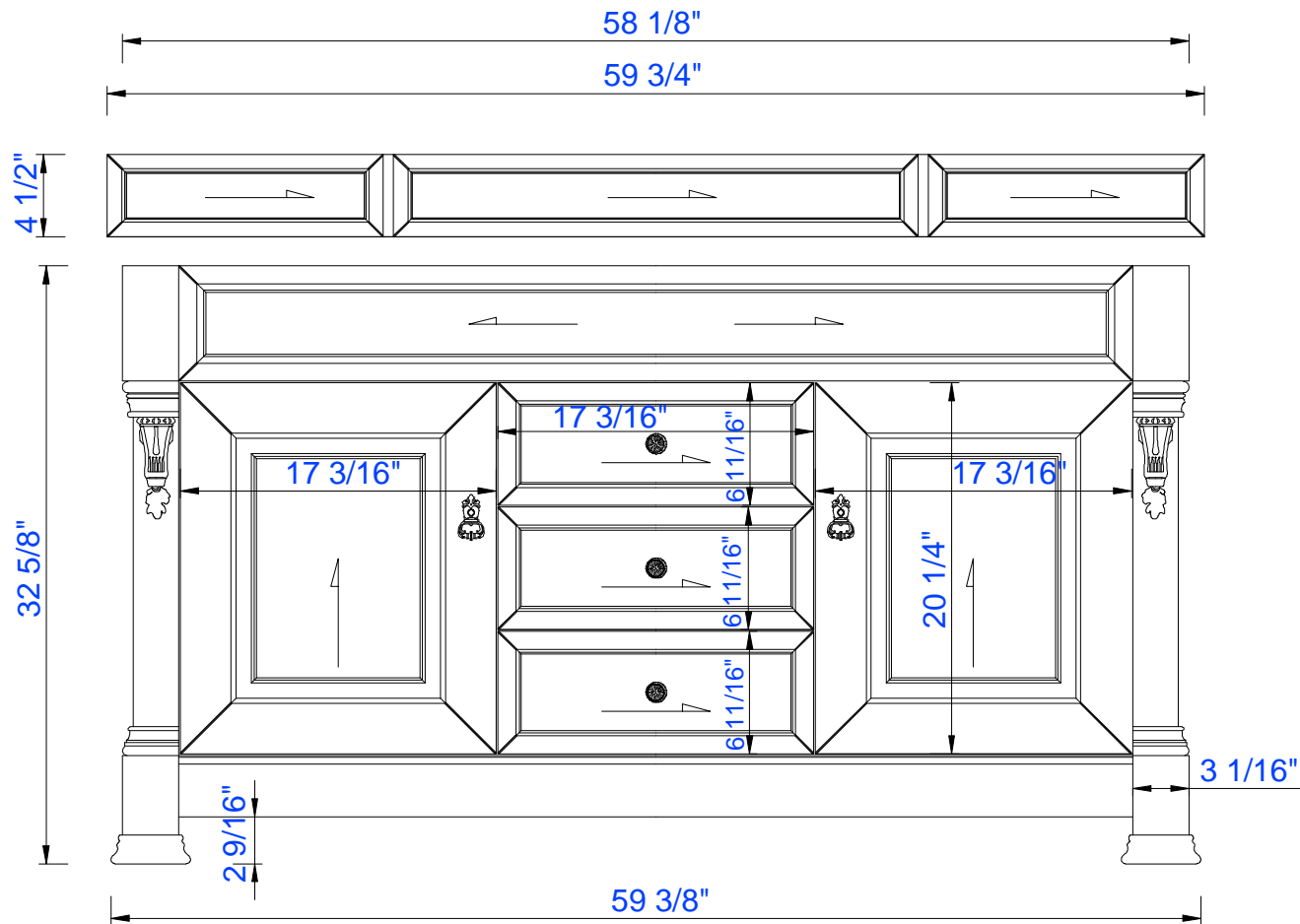

NOTE ONE: Countertops are not shown in these diagrams. (Cabinet Only)

NOTE TWO: Wood Backsplash (Shown) is designed for the molding detail to align with sinks in James Martin's Optional Countertops. Customers' own countertops and sinks may align differently.

Please consult our website for Countertop Diagrams: [www.jamesmartinvanities.com](http://www.jamesmartinvanities.com)

Version: 202005

60" S

Item Number:

- 147-114-5331
- 147-114-5341
- 147-114-5361
- 147-114-5371
- 147-114-5381

JAMES MARTIN

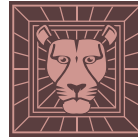

VANITIES™

Brookfield 60" Cabinet

Diagrams with Dimensions  
page 02 of 03

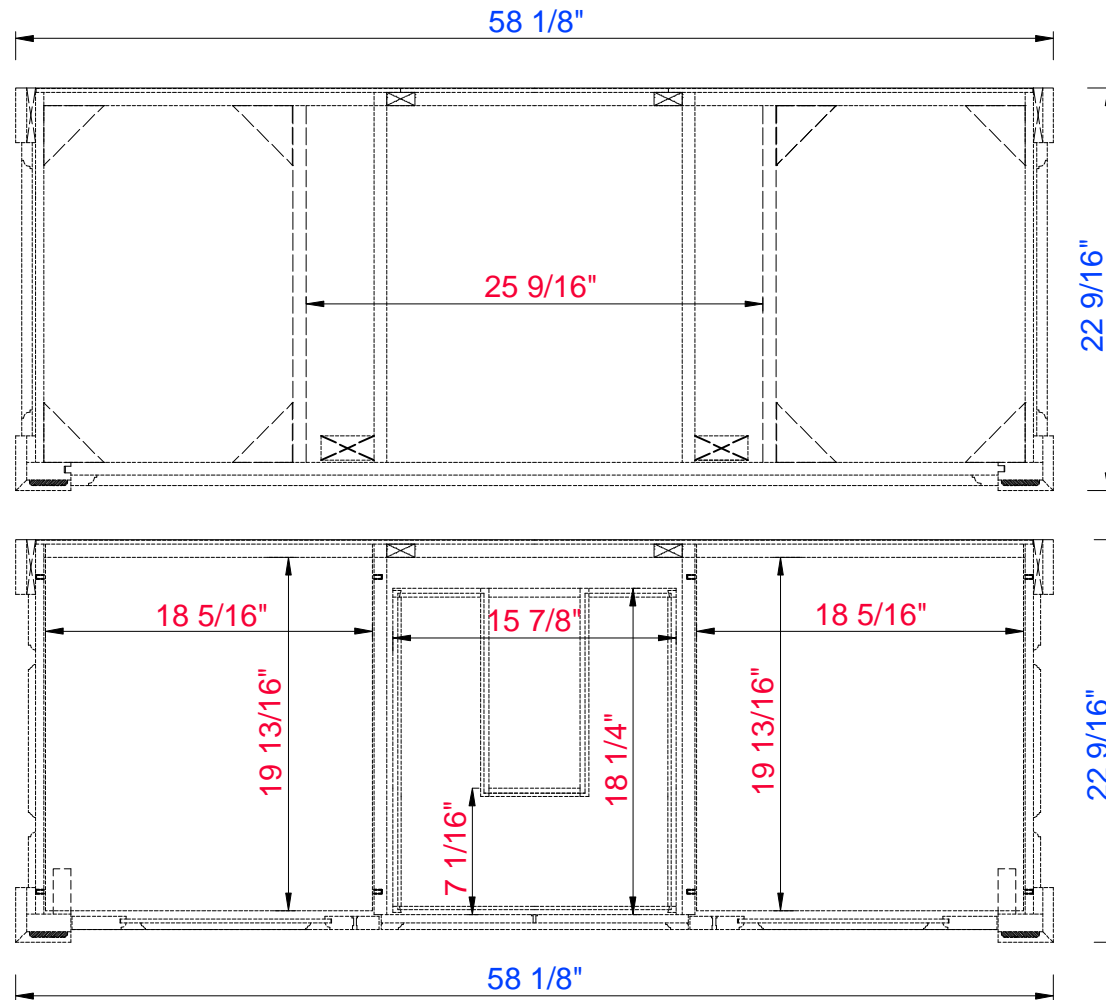

NOTE ONE: Countertops are not shown in these diagrams. (Cabinet Only)

NOTE TWO: Internal Shelves (Shown) are designed to align with sinks in James Martin's Optional Countertops. Customers' own countertops and sinks may align differently, and modification may be required. Please consult our website for Countertop Diagrams: [www.jamesmartinvanities.com](http://www.jamesmartinvanities.com)

60" S

Item Number:

- 147-114-5331
- 147-114-5341
- 147-114-5361
- 147-114-5371
- 147-114-5381

JAMES MARTIN

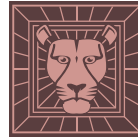

VANITIES™

Brookfield 60" Cabinet

Diagrams with Dimensions  
page 03 of 03

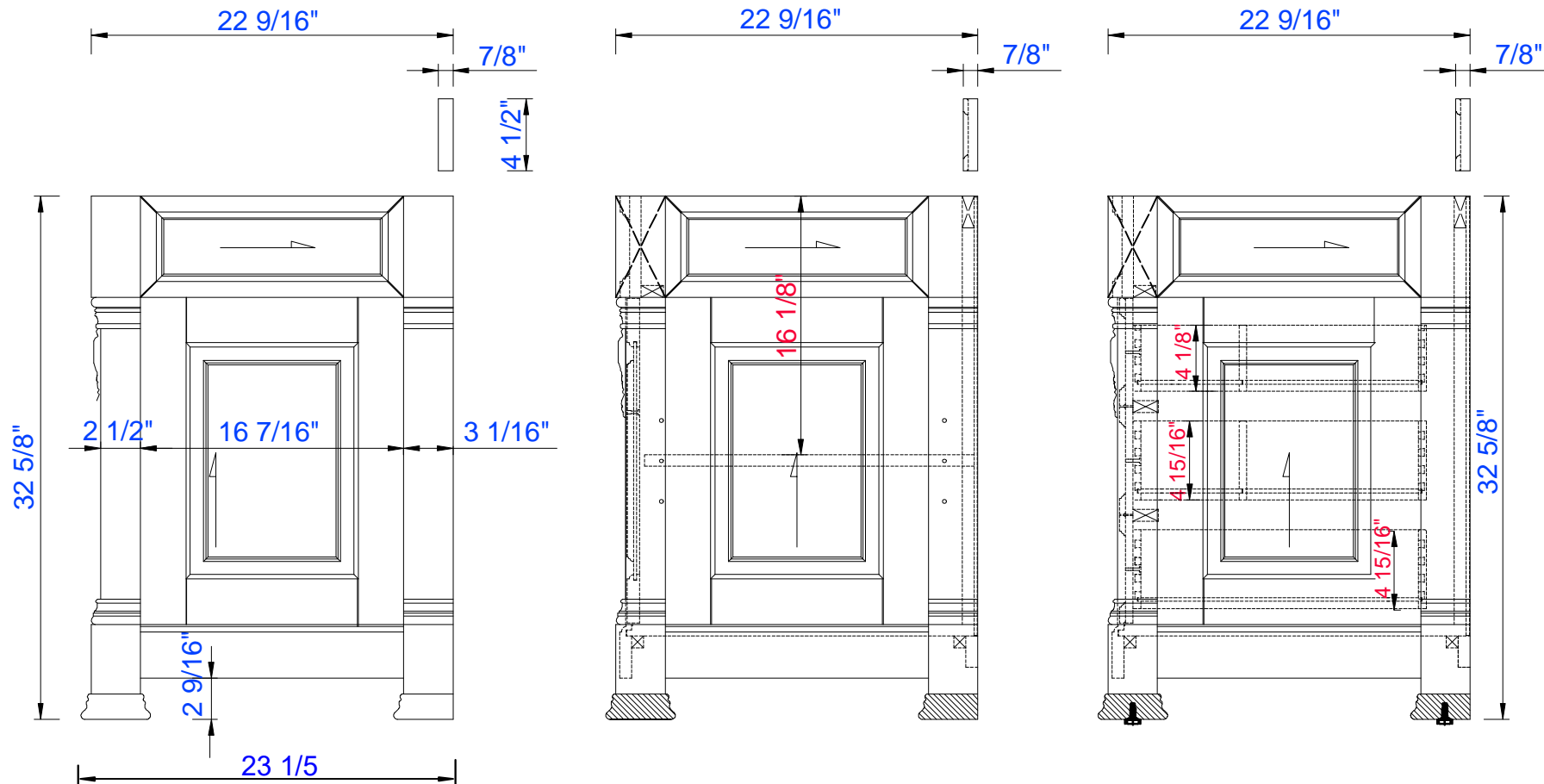

NOTE ONE: Countertops are not shown in these diagrams. (Cabinet Only)

NOTE TWO: Wood Backsplash (Shown) is designed for the molding detail to align with sinks in James Martin's Optional Countertops. Customers' own countertops and sinks may align differently.

Please consult our website for Countertop Diagrams: [www.jamesmartinvanities.com](http://www.jamesmartinvanities.com)

Version: 202005

1524mm

Item Number:

- 147-114-5331
- 147-114-5341
- 147-114-5361
- 147-114-5371
- 147-114-5381

JAMES MARTIN

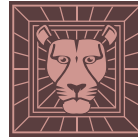

VANITIES™

Brookfield 1524mm Cabinet

Diagrams with Dimensions  
page 01 of 03

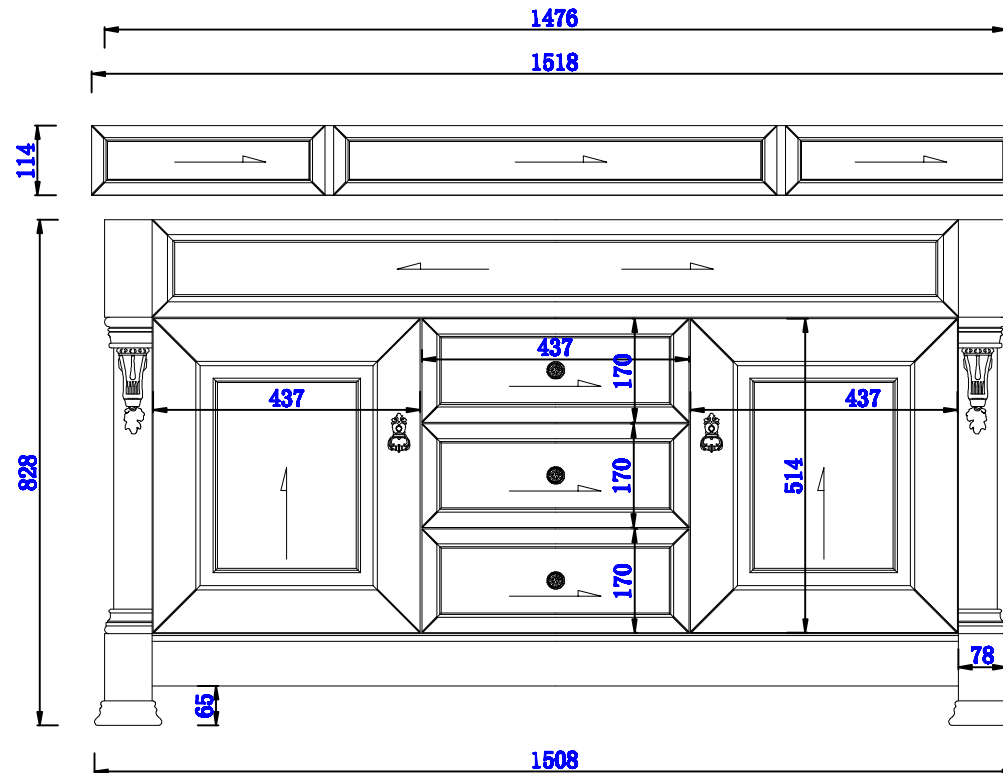

NOTE ONE: Countertops are not shown in these diagrams. (Cabinet Only)

NOTE TWO: Wood Backsplash (Shown) is designed for the molding detail to align with sinks in James Martin's Optional Countertops. Customers' own countertops and sinks may align differently.

Please consult our website for Countertop Diagrams: [www.jamesmartinvanities.com](http://www.jamesmartinvanities.com)

Version: 202005



1524mm

Item Number:

- 147-114-5331
- 147-114-5341
- 147-114-5361
- 147-114-5371
- 147-114-5381

JAMES MARTIN

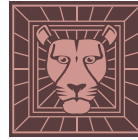

VANITIES™

Brookfield 1524mm Cabinet

Diagrams with Dimensions  
page 02 of 03

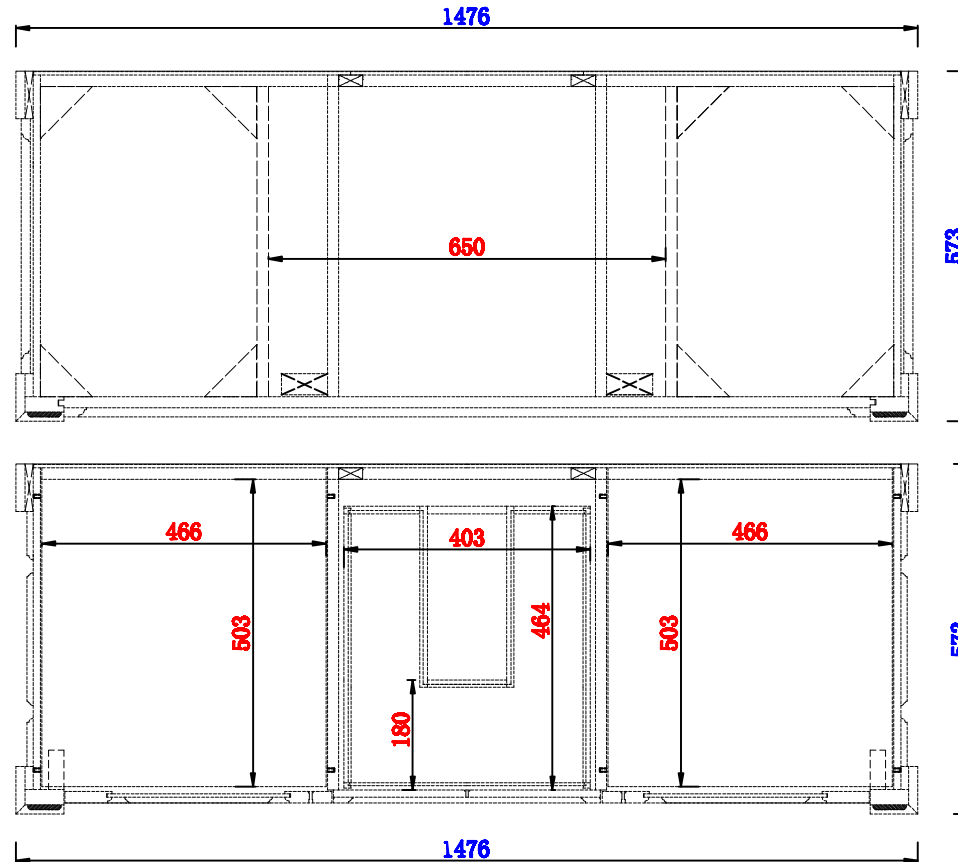

NOTE ONE: Countertops are not shown in these diagrams. (Cabinet Only)

NOTE TWO: Internal Shelves (Shown) are designed to align with sinks in James Martin's Optional Countertops. Customers' own countertops and sinks may align differently, and modification may be required. Please consult our website for Countertop Diagrams: [www.jamesmartinvanities.com](http://www.jamesmartinvanities.com)

1524mm

Item Number:

- 147-114-5331
- 147-114-5341
- 147-114-5361
- 147-114-5371
- 147-114-5381

JAMES MARTIN

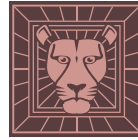

VANITIES™

Brookfield 1524mm Cabinet

Diagrams with Dimensions  
page 03 of 03

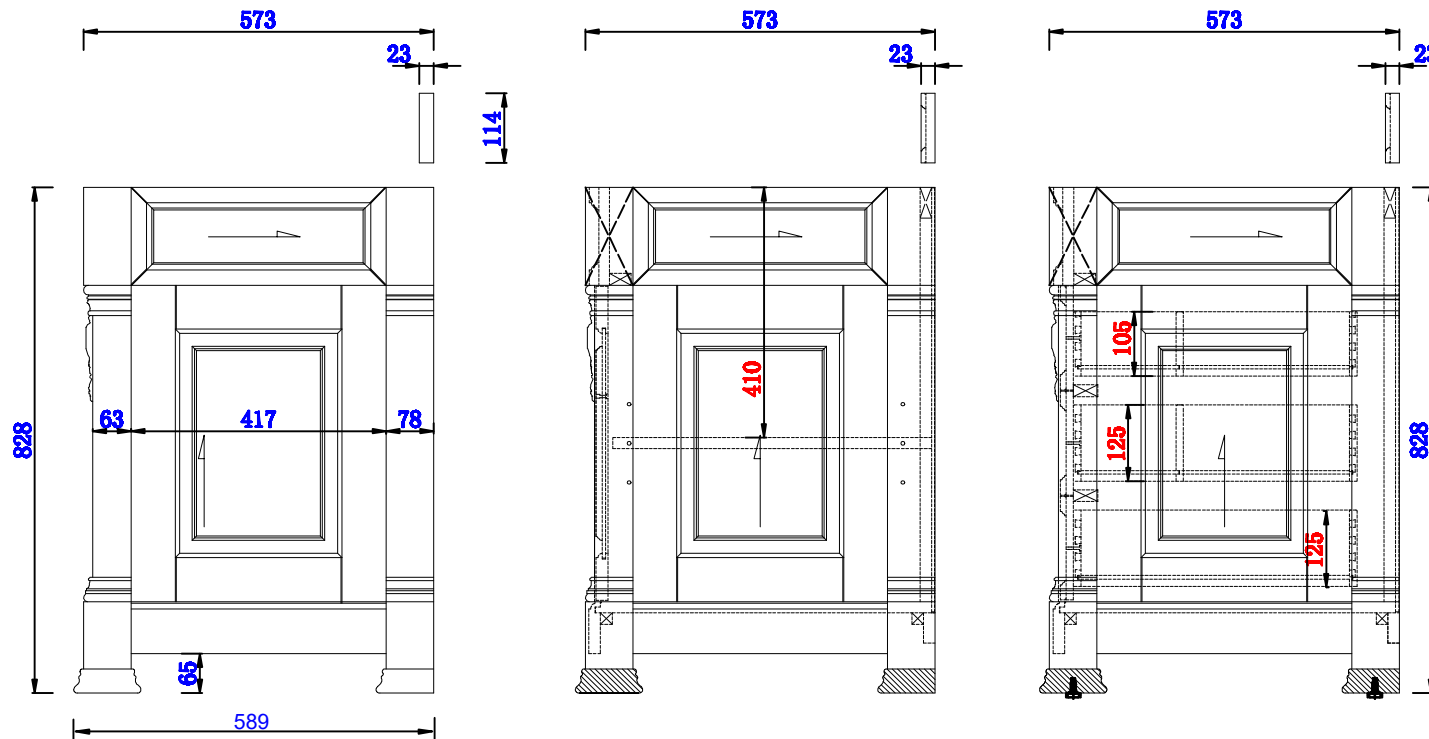

NOTE ONE: Countertops are not shown in these diagrams. (Cabinet Only)

NOTE TWO: Wood Backsplash (Shown) is designed for the molding detail to align with sinks in James Martin's Optional Countertops. Customers' own countertops and sinks may align differently.

Please consult our website for Countertop Diagrams: [www.jamesmartinvanities.com](http://www.jamesmartinvanities.com)