

47.3"

Item Number:
801-V47.3-GW
801-V47.3-WLT
801-V47.3-MGG

JAMES MARTIN



VANITIES™

Milan 47.3" Single Vanity Cabinet
Diagrams with Dimensions
page 01 of 03

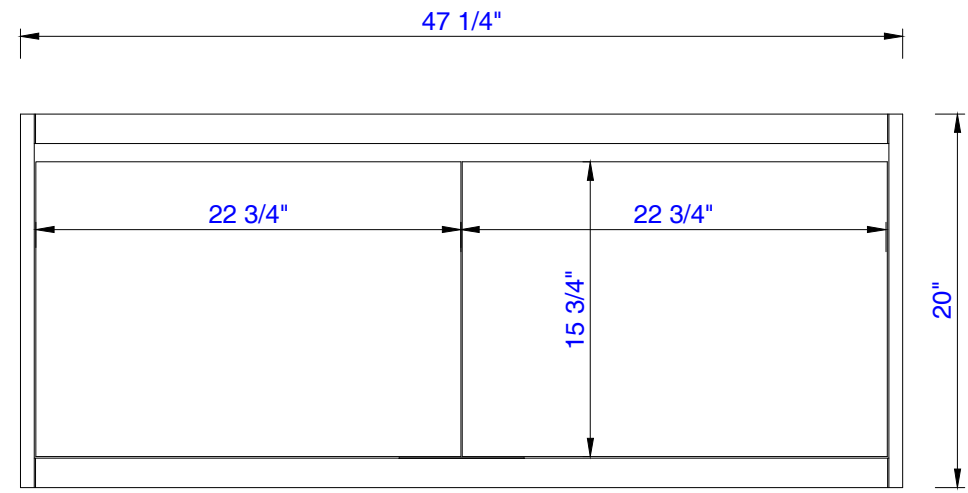

NOTE ONE: Countertops are not shown in these diagrams. (Cabinet Only)

NOTE TWO: This vanity does not have a Backsplash.

Please consult our website for Countertop Diagrams: www.jamesmartinvanities.com

Version:202011

47.3"

Item Number:
801-V47.3-GW
801-V47.3-WLT
801-V47.3-MGG

JAMES MARTIN



VANITIES™

Milan 47.3" Single Vanity Cabinet
Diagrams with Dimensions
page 02 of 03

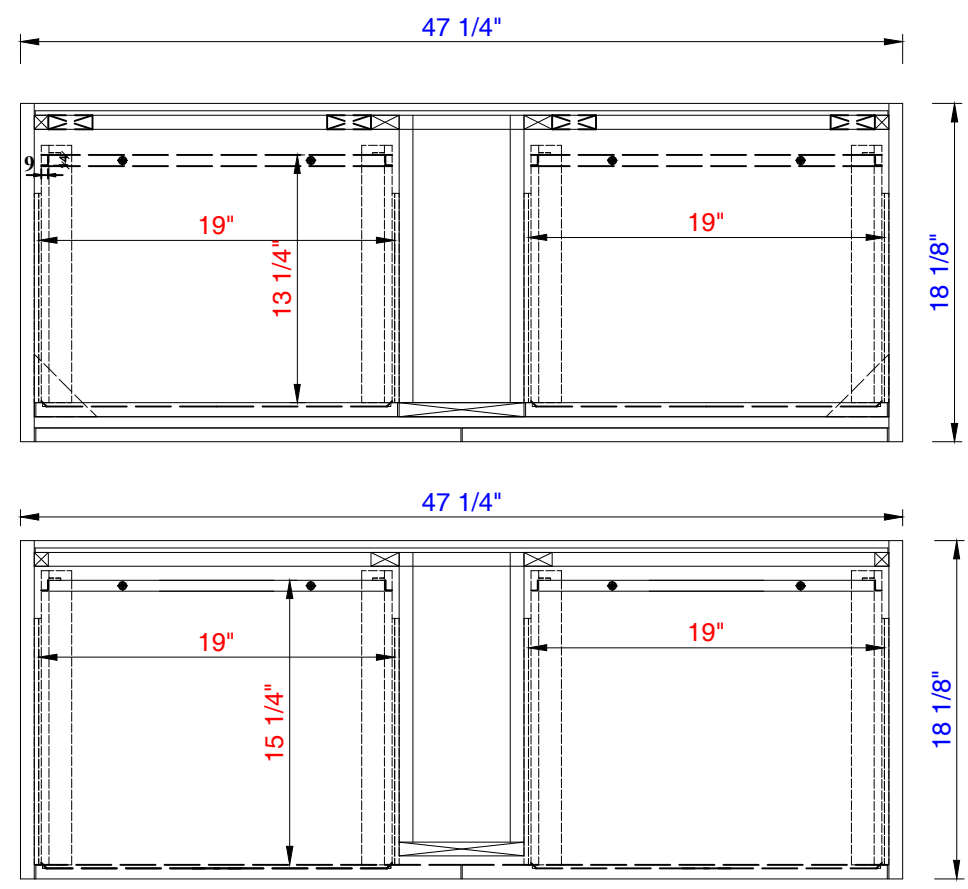

NOTE ONE: Countertops are not shown in these diagrams. (Cabinet Only)
NOTE TWO: Drawers (Shown) are designed to align with sinks in James Martin's Optional Countertops.
Customer's own countertops and sinks may align differently, and modification may be required.
Please consult our website for Countertop Diagrams: www.jamesmartinvanities.com

47.3"

Item Number:
801-V47.3-GW
801-V47.3-WLT
801-V47.3-MGG

JAMES MARTIN

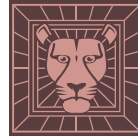

VANITIES™

Milan 47.3" Single Vanity Cabinet
Diagrams with Dimensions
page 03 of 03

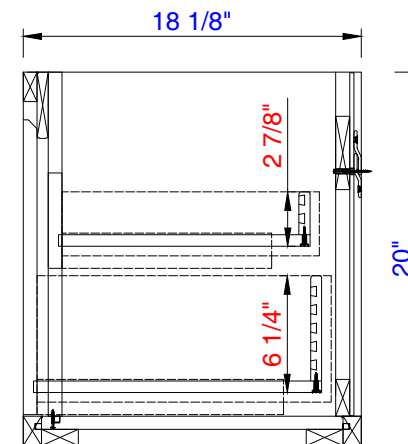
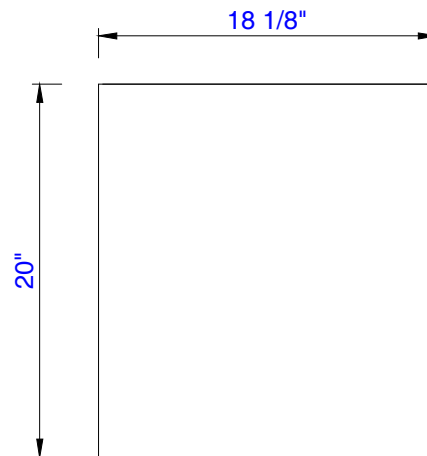

NOTE ONE: Countertops are not shown in these diagrams. (Cabinet Only)

NOTE TWO: This vanity does not have a Backsplash.

Please consult our website for Countertop Diagrams: www.jamesmartinvanities.com

Version:202011

1200mm

Item Number:
801-V47.3-GW
801-V47.3-WLT
801-V47.3-MGG

JAMES MARTIN

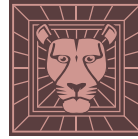

VANITIES™

Milan 1200mm Single Vanity Cabinet

Diagrams with Dimensions
page 01 of 03

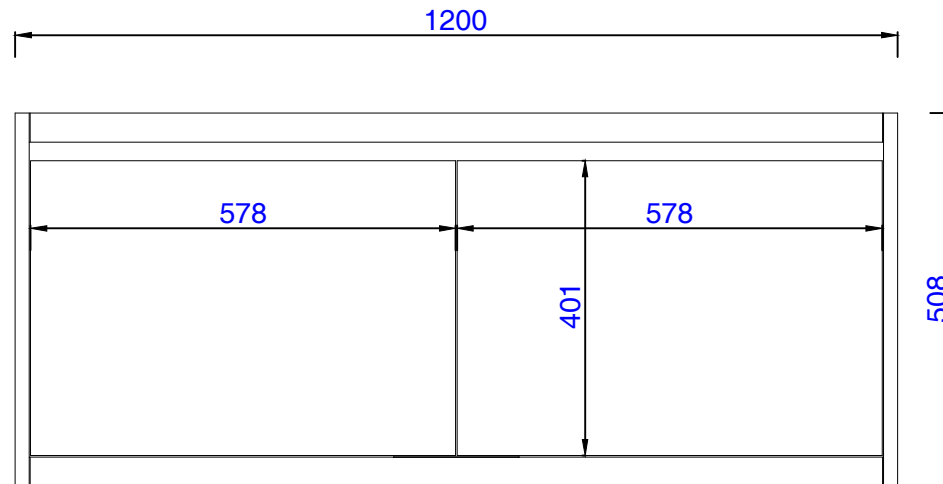

NOTE ONE: Countertops are not shown in these diagrams. (Cabinet Only)

NOTE TWO: This vanity does not have a Backsplash.

Please consult our website for Countertop Diagrams: www.jamesmartinvanities.com

Version:202011

1200mm

Item Number:
801-V47.3-GW
801-V47.3-WLT
801-V47.3-MGG

JAMES MARTIN

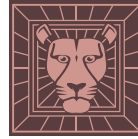

VANITIES™

Milan 1200mm Single Vanity Cabinet

Diagrams with Dimensions
page 02 of 03

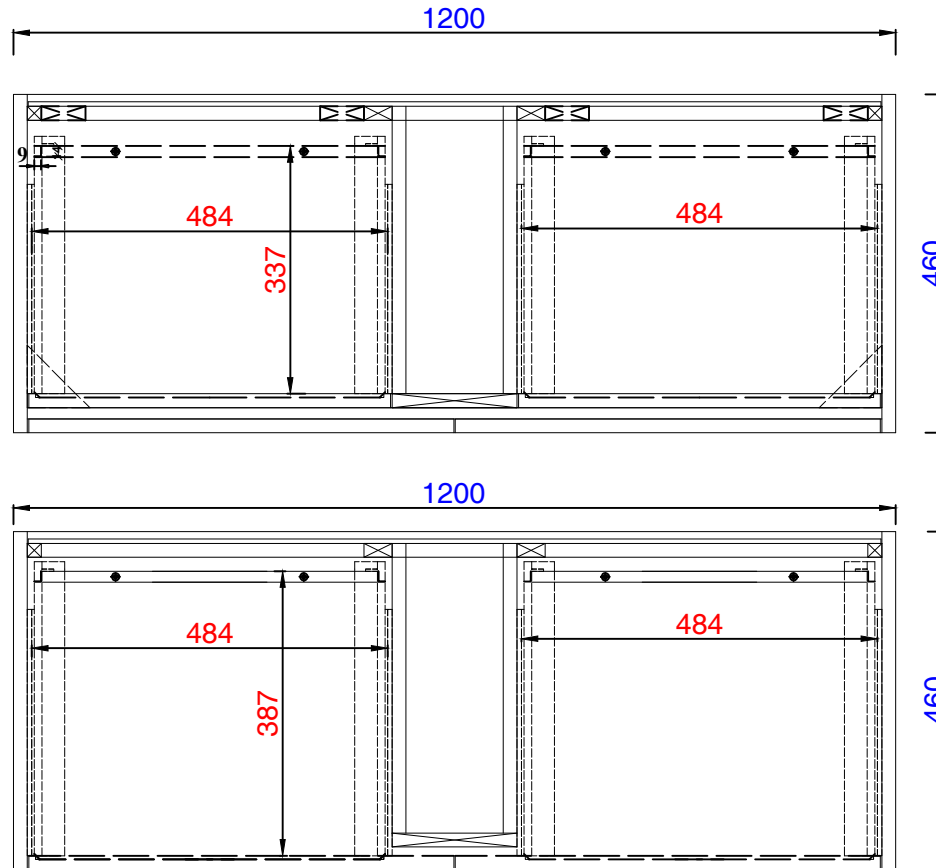

NOTE ONE: Countertops are not shown in these diagrams. (Cabinet Only)

NOTE TWO: Drawers (Shown) are designed to align with sinks in James Martin's Optional Countertops.

Customer's own countertops and sinks may align differently, and modification may be required.

Please consult our website for Countertop Diagrams: www.jamesmartinvanities.com

Version:202011

1200mm

Item Number:
801-V47.3-GW
801-V47.3-WLT
801-V47.3-MGG

JAMES MARTIN



VANITIES™

Milan 1200mm Single Vanity Cabinet

Diagrams with Dimensions
page 03 of 03

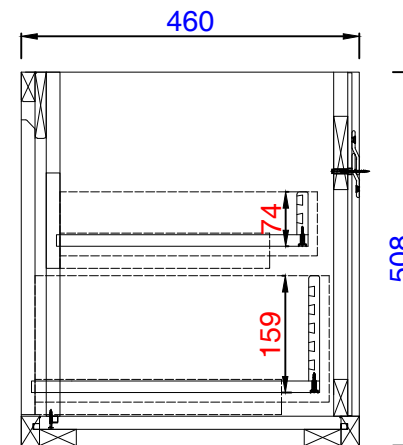
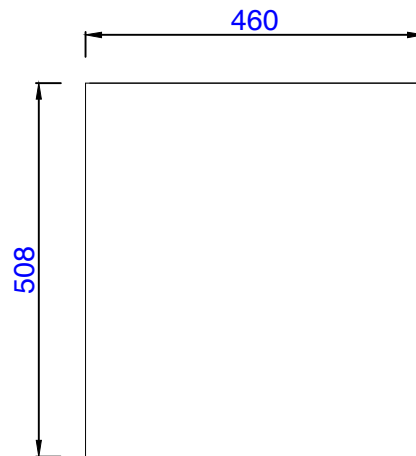

NOTE ONE: Countertops are not shown in these diagrams. (Cabinet Only)

NOTE TWO: This vanity does not have a Backsplash.

Please consult our website for Countertop Diagrams: www.jamesmartinvanities.com

Version:202011